



TKN[®]
GROUP

Hareketli Yapı Sistemleri

S

S

Guillotine Systems



Hakkımızda

About Us

Adana'da 24.000 m²'lik üretim tesisinde faaliyet gösteren TKN Group, bioklimatik, rolling roof, tente, pergola, giyotin cam ve zip perde sistemleri üretiminde sektörün lider firmalarından biridir. 100 kişilik uzman ekibiyle, yüksek kalite standartları ve müşteri memnuniyeti odaklı yaklaşımıyla her türlü mekan için yenilikçi ve dayanıklı çözümler sunmaktadır. Yıllık 500 bin m² demonte üretim kapasitesi ve 2.000 ton boyama kapasitesi ile güçlü bir üretim altyapısına sahip olan TKN Group, ürünlerini demonte olarak sevk ederek montaj kolaylığı sağlamaktadır.

TKN Group, sadece Türkiye'deki müşterilerine değil, dünya çapında 45 farklı ülkeye de ürünlerini ulaştırmaktadır. Geniş ürün yelpazesi ile her ihtiyaca uygun çözümler sunarak, dış mekanları estetik ve fonksiyonel hale getirmektedir. Modern üretim teknikleri ve yüksek mühendislik bilgisiyle, her bir ürünü mükemmel kaliteyle üreten firma, sektördeki deneyimiyle sürekli yenilikçi çözümler geliştirmektedir.

Yeni yatırımlar ve teknolojik ekipmanlarla üretim ağını sürekli güçlendiren TKN Group, fabrikasını sürekli olarak geliştirerek, gelişen teknolojilere ayak uydurmaktadır. Her zaman müşteri memnuniyetini en üst seviyede tutarak, kaliteli ve güvenilir ürünlerle yaşam alanlarını dönüştürmeyi hedeflemektedir.

Operating in a 24,000 m² production facility in Adana, TKN Group is one of the leading companies in the sector in the production of bioclimatic, rolling roof, awning, pergola, guillotine glass and zip curtain systems. With its expert team of 100 people, it offers innovative and durable solutions for all types of spaces with its high quality standards and customer satisfaction-oriented approach. With its strong production infrastructure of 500 thousand m² demounted production capacity and 2,000 tons of painting capacity per year, TKN Group provides ease of assembly by shipping its products demounted.

TKN Group delivers its products not only to its customers in Turkey but also to 45 different countries around the world. It makes outdoor spaces aesthetic and functional by offering solutions suitable for every need with its wide product range. The company, which produces each product with excellent quality with its modern production techniques and high engineering knowledge, constantly develops innovative solutions with its experience in the sector.

TKN Group, which constantly strengthens its production network with new investments and technological equipment, constantly develops its factory and keeps up with developing technologies. It aims to transform living spaces with quality and reliable products, always keeping customer satisfaction at the highest level.

- Dekoratif gizli üst LED lambası ile estetik görünüm
- Uzaktan kumanda ile düşeyde açılıp kapanabilen.
- Balkon korkuluğu olarak kullanılan sistemler.
- Kullanım alanları; konut, villa, teras ve restoranlar.
- Küpeşte pozisyonunda temizlenebilmektedir.
- Hareketli üst küpeşte profili sayesinde el sıkışması önlenmektedir
- Yüksek yoğunluklu fırça fitil ve contalar kullanılmaktadır.
- Yağışlı havalarda tam koruma sağlar.

- Aesthetic appearance with decorative hidden top led lamp
- Can be opened and closed vertically with remote control.
- Systems used as balcony railing.
- Usage areas; houses, villas, terraces and restaurants.
- It can be cleaned in the railing position.
- Hand drawing is prevented thanks to the movable upper railing profile
- High density brush wicks and seals are used.
- Provides full protection in rainy weather.



MALZEME TEKNİK ÖZELLİKLERİ / TECHNICAL PROPERTIES OF MATERIALS

-Profil Hammaddesi (Raw Material): AA 6063 (AlMgSi 0.5 F22) , EN 573-3 Mekanik Özellikler (Mechanical Properties) : EN 755-2 Yoğunluk (Density) : 2.71 g/cm³ Elastisite Modülü (Elastiody moduli): 7000 kN/cm² Kopma Mukavemeti (Yield Strenght): 215 N/mm² Akma Mukavemeti (Flow Strenght): 160 N/mm² Uzama (songation) : minimum 6 Vo Sertlik (Hardness) : 70 HRB

-Eloksal(Anodic Oxidation) Eloksallı Ürünlere ilişkin Teknik Resim Standardı : DIN 17611 , EN 12371-1 (QUALANOD) (The Standarts of Technical Delivery Terms Regarding Eloxal Products) Eloksal Tabakasının Kalınlığı (Thickness of Eloxal Coating): 10-15 mikron, EN ISO 2360 Daldırma ve Renklendirme Standardı (The Standarts of Immersion Coloring) : DIN 50018 Tesbit işleme Standardı (Sealing Standarts) : EN 12373-5 , ISO 3210 (TS 2676) -Toz Boya Standartları (The Standarts of Powder Coating) Kain-dik (Thickness) : min. 60 mikron Adhezyon (Adhesion): EN ISO 2409 Esneklik (Elasticity) : EN ISO 1519 Deformasyon (Deformation): EN ISO 6272-1 Sertlik(Hardness): EN ISO 2815

-Yüzey Görünümü (Surface Appearance): Gözle yapılacak kontrolde,yüzey üzerinde kaplanmış alan, çizik, pütürlük, kabarıklık, leke, soyulma vb. hatalar görülmemelidir. (By visuai observation,there ha been no defects seen on the surface,such as stratches cramped shapes,swellings,stain etc. on the exposed areas.)

-Tüm Fitiller(Aıı gaskets) Hammadde (Raw material) : EPDM Derz fitilleri hammaddesi (Raw matedddi of Gaskets for suture): Silikon (Silicone) Ölçü Toleransları Standardı(Measurement Tolerances Standarts): DIN ISO 3302-1/E2 Kalite Kontrol Standardı (Quality Corfiroi Standart): RAL-GZ 716

-Profil Tasarım ve Üretimindeki Ölçü Toleransları Standartları : EN 12020-2 (Measurement Tolerances Standarts for Profile Design and Manufacturing)



- Mevcut profiller ile silinebilir ve standart giyotin tasarlanabilir.
- Elektronik kontrol switch ile açılır kanat açık iken motor devreye girmez .
- Kullanım alanları; konut, villa, teras ve restoranlar.
- Mevcut profilleri ile ikili üçlü silinebilir veya standart giyotin yapılabilir giyotin sistemimiz terste toplanabilir .
- Yüksek yoğunluklu fırça fitil ve contalar kullanılmaktadır. yağışlı havalarda tam koruma sağlar.
- Hareketli ekipmanları zincir - kayış ve milli yapılabilir .
- Kanat profillerinde yalıtım ve izolasyon için çift conta ile desteklenmektedir.
- Güvenlik nedeniyle sadece küpeşte pozisyonunda temizlenebilmektedir.
- Hareketli üst küpeşte profili sayesinde el sıkışması önlenmektedir.
- Giyotin üretimini desteklemek için sistemde kертme ve kırk beş kesim yoktur.
- Vasistas çelik güçlendirilmiştir ve lama ile desteklenmektedir.

- Existing profiles can be deleted and standard guillotine can be designed.
- It is opened with an electronic control switch, the motor does not start when the wing is open.
- Usage areas; residences, villas, terraces and restaurants.
- With existing profiles, double or triple can be deleted or a standard guillotine can be made, our guillotine system can be collected in reverse.
- High density brush wick and seals are used. Provides full protection in rainy weather.
- Moving equipment can be made with chains, belts and shafts.
- The wing profiles are supported by double seals for insulation and isolation.
- For safety reasons, it can only be cleaned in the handrail position.
- Hand jamming is prevented thanks to the movable upper handrail profile.
- There is no notching and forty-five cuts in the system to support guillotine production.
- The transom is reinforced with steel and supported by a sheet metal.



TKN[®]
GROUP

Hareketli Yapı Sistemleri



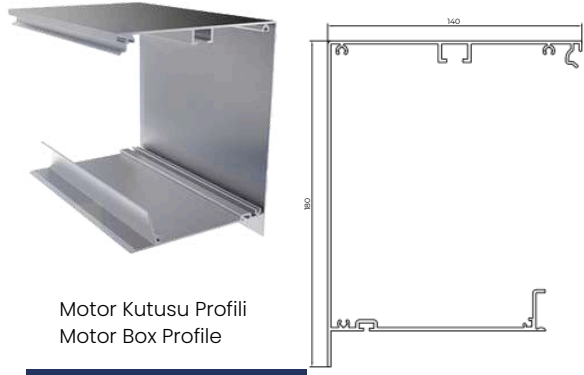

Motor Kutusu Profili
Motor Box Profile

Product Code: 3668

Weight kg/m : 2,764
(180x140x1,8 mm)



Motor Kutusu Kapağı
Motor Box Cover

Product Code: 3669

Weight kg/m : 1.038
(157x28,7x2 mm)



LED Kapağı
LED Cover

Product Code: 2716

Weight kg/m : 0,166
(24.6x14.7x1.2mm)



Yan Kanat Profili
Side Sash Profile

Product Code: 3670

Weight kg/m : 0,865
(52.9x25.2x1.5mm)

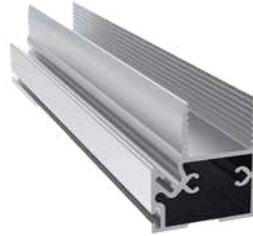

Kenet Profili
Clamp Profile

Product Code: 3671

Weight kg/m : 4,200
(70 x 298 x 2mm)

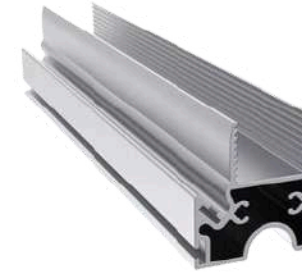

Hareketli Kenet Profili
Active Clamp Profile

Product Code: 3672

Weight kg/m : 0,821
(40x35.1x1.5mm)



Hareketli Küpeşte Cam Profili
Movable Railing Glass Profile

Product Code: 3673

Weight kg/m : 0,672
(40x25.2x1.5mm)

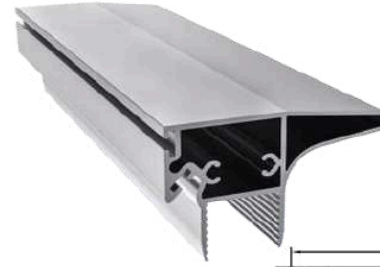
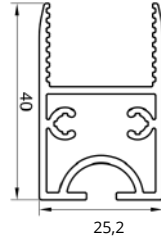

Tutamaklı Baza Profili
Base Profile with Handle

Product Code: 3674

Weight kg/m : 1.038
(68.1x40x1.5 mm)

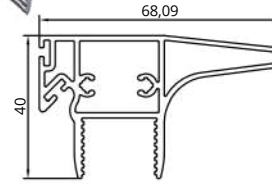

Sabit Kanat Kilit Profili
Fixed Wing Lock Profile

Product Code: 3675

Weight kg/m : 1.390
(78.5x42x1.5 mm)

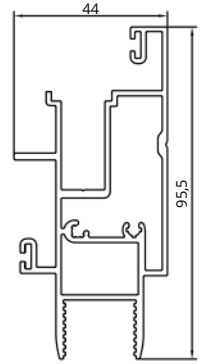

Vasistas Makas Ray Profili
Transom Scissor Rail Profile

Product Code: 3676

Weight kg/m : 0.233
(23.94x9.8x1.8mm)

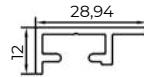

8 mm Adaptör
8mm Adapter

Product Code: 3677

Weight kg/m : 0.323
(20.5x16.85x1.2mm)

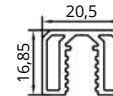

Ray iç Tirnak Profili
Ray Inner Profile

Product Code: 3678

Weight kg/m : 0.569
(75x19.1x1.8mm)

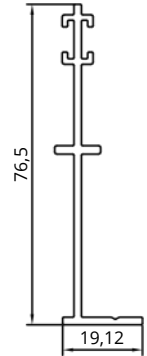

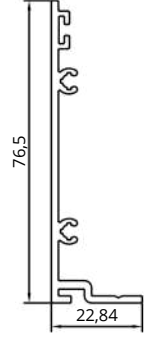
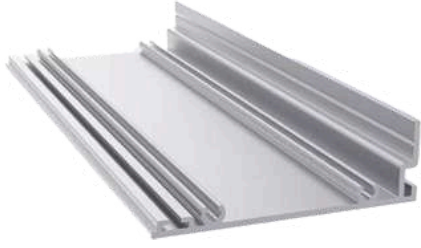

Ray Dış Tırnak Profili
Ray External Nail Profile

Product Code: 3679

Weight kg/m : 0.613
(75.5x22x84x1.8mm)



Ray Dış Dikme Profili
Rail Outer Post Profile

Product Code: 3680

Weight kg/m : 1.748
(114.6x97x1.5mm)

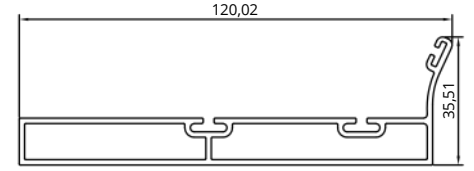
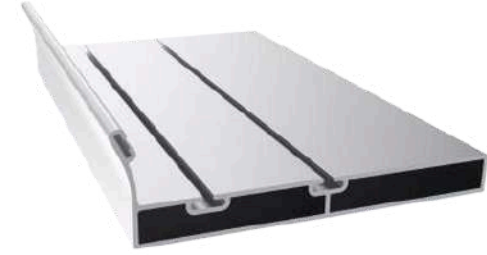

Alt Kasa Profili
Top Frame Profile

Product Code: 3681

Weight kg/m : 1.748
(122x35.5x1.5mm)

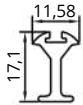

Alt Baza Vasistas Adaptör
Lower Base Transom Adapter

Product Code: 3682

Weight kg/m : 0.187
(17x11.5x2.5mm)

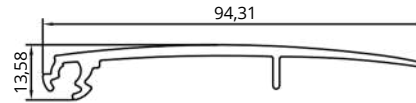

Hareketli Küpeşte Kapak Profili
Movable Railing Cover Profile

Product Code: 3683

Weight kg/m : 0.612
(94.3x12.9x2mm)

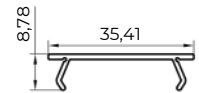

Ray Kapak Profili
Rail Cover Profile

Product Code: 3684

Weight kg/m : 0.0171
(35.4x8.7x1.3mm)

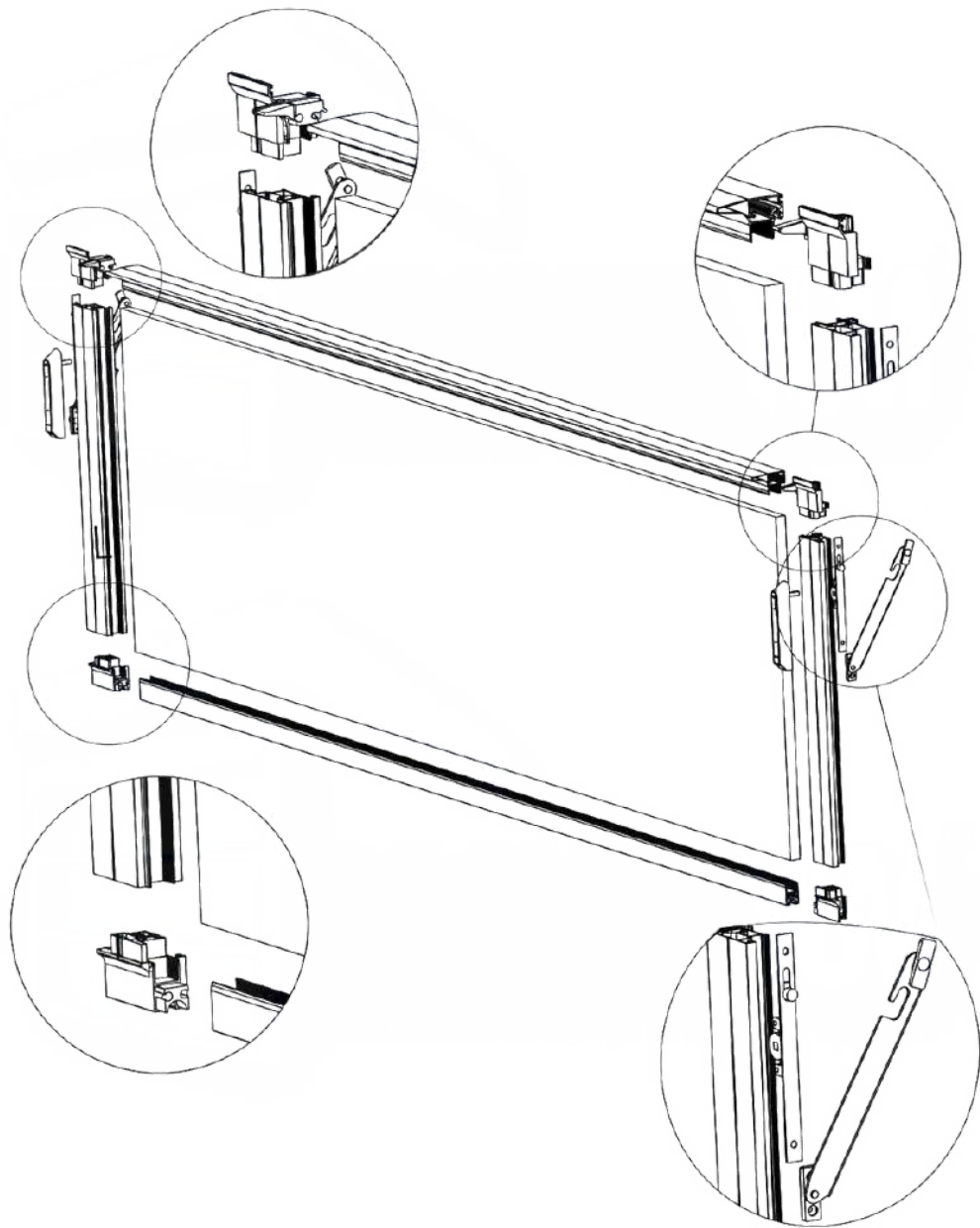

Sistemlerimizde kullanılan motor kutusu yan kapakları alüminyum döküm takozlardan oluşmaktadır bu sayede kırılma yıpranma gibi kötü hava koşullarının oluşturduğu sirkülasyonlara karşı mukavemet sağlamaktadır

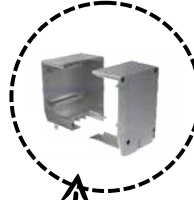

The engine box side covers used in our systems are made of aluminum casting wedges, thus providing resistance against circulation caused by bad weather conditions such as breakage and wear.

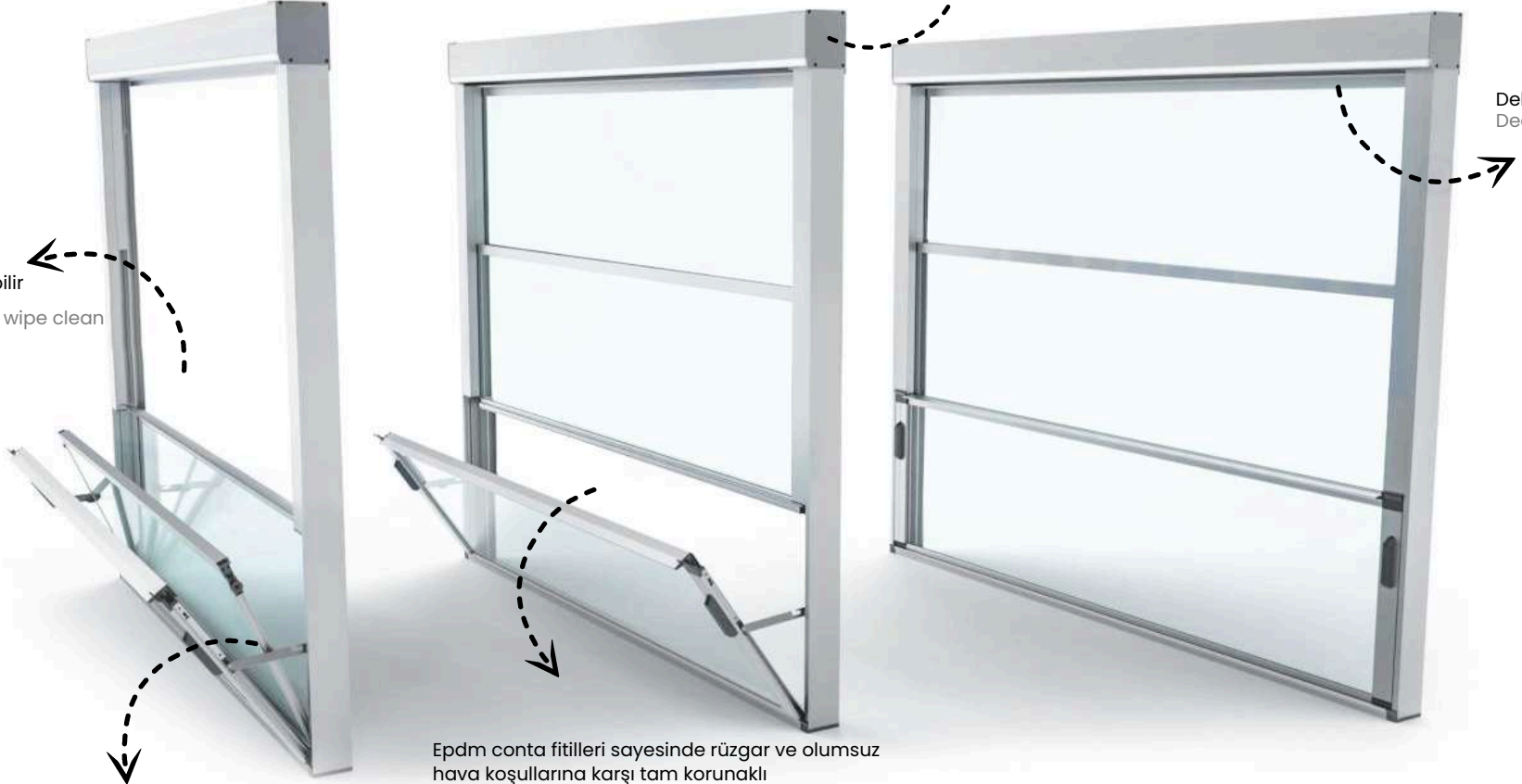

Tam açılabilir ve kolay silenebilir
Fully openable and easy to wipe clean

Dekoratif üst led lambası
Decorative top LED lamp

Orta destek vasıtası ile
güvenli açılımı
Safe opening with middle support transom

Epdm conta fitilleri sayesinde rüzgar ve olumsuz
hava koşullarına karşı tam korunaklı

Fully protected against wind and adverse
weather conditions thanks to EPDM seal wicks



Motor Kutusu Takozu
Corner Cleats Bracker

Product Code: **GYT-001**



Bağlantı Plakası
Connection Plate

Product Code: **GYT-002**



Rulman Yatağı
Roller Bearing

Product Code: **GYT-003**

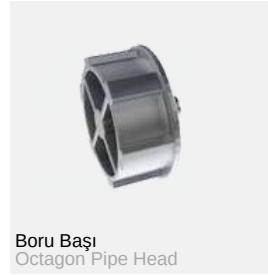

Boru Başı
Octagon Pipe Head

Product Code: **GYT-004**



Zincir Dişlisi
Chain Gear

Product Code: **GYT-005**

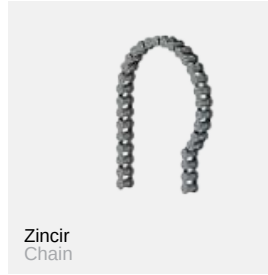

Zincir
Chain

Product Code: **GYT-006**



Zincir Yönlendirici
Chain Transfer Plastic

Product Code: **GYT-007**

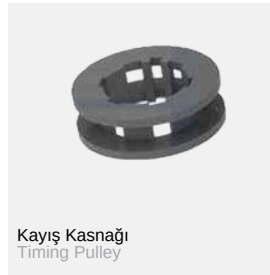

Kayış Kasnağı
Timing Pulley

Product Code: **GYT-008**

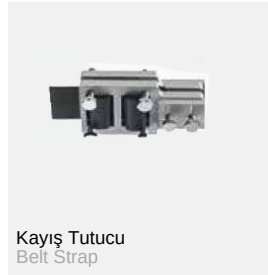

Kayış Tutucu
Belt Strap

Product Code: **GYT-009**

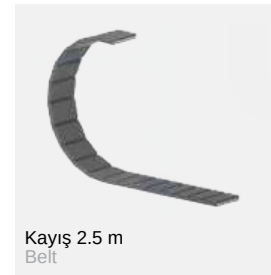

Kayış 2.5 m
Belt

Product Code: **GYT-010**



Merkezeleme Takozu
Centering Apparatus

Product Code: **GYT-011**

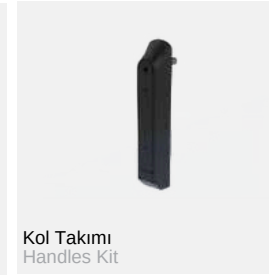

Kol Takımı
Handles Kit

Product Code: **GYT-012**

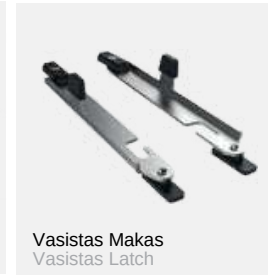

Vasistas Makas
Vasistas Latch

Product Code: **GYT-013**

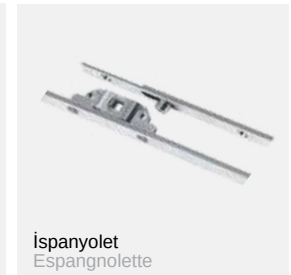

İspanyolet
Espagnolette

Product Code: **GYT-014**



Vasistas Alt Profil Plastiği
Transactional Lower Profile Plastic

Product Code: **GYT-015**



Orta Vasistas Köşe Takozu
Middle Transom Corner Wedge

Product Code: **GYT-016**



Hareketli Üst Köşe Takozu
Mowing Top Corner Wedge

Product Code: **GYT-017**



Vasistas üst Zincir Kapak
Transom upper Chain Cover

Product Code: **GYT-018**



Kanat Köşe Plastiği
Sash Corner Plastic

Product Code: **GYT-019**



Kenetli Baza Profil Plastiği
Clamped Base Profile Plastic

Product Code: **GYT-020**



Kasa Köşe Birleştirme Takozu
Corner Cleats Bracket

Product Code: **GYT-021**



Hareketli K peşte Kenar Kapađı
Movable Handrail Edge Cover

Product Code: **GYT-022**



Giyotinyum Fırça Fitill
Giyotinyum Brush Wick

Product Code: **GYT-023**



Epdm Kenet Fitili
Weather Clamped Strip

TKN-000 **GYT-024**

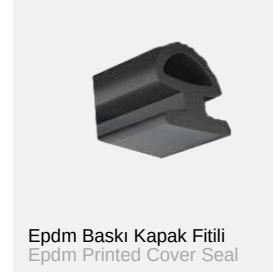

Epdm Baskı Kapak Fitili
Epdm Printed Cover Seal

Product Code: **GYT-025**

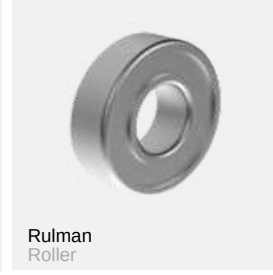

Rulman
Roller

Product Code: **GYT-026**

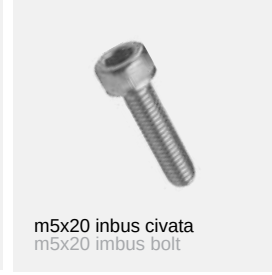

m5x20 inbus civata
m5x20 imbus bolt

Product Code: **GYT-027**

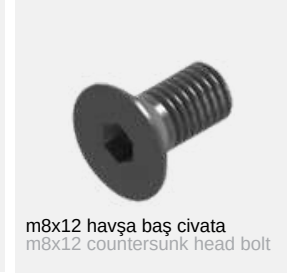

m8x12 havşa bař civata
m8x12 countersunk head bolt

Product Code: **GYT-028**

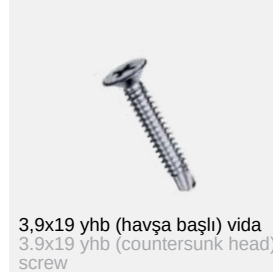

3,9x19 yhb (havşa bařlı) vida
3.9x19 yhb (countersunk head)
screw

Product Code: **GYT-029**

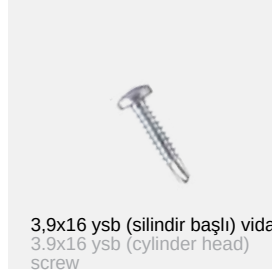

3,9x16 ysb (silindir bařlı) vida
3.9x16 ysb (cylinder head)
screw

Product Code: **GYT-030**

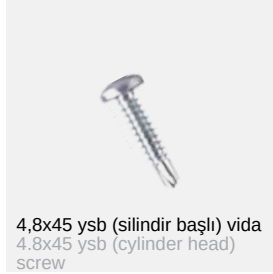

4,8x45 ysb (silindir bařlı) vida
4.8x45 ysb (cylinder head)
screw

Product Code: **GYT-031**

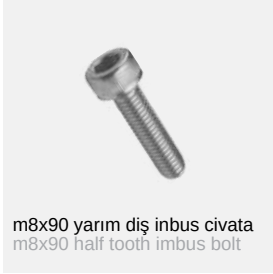

m8x90 yarım diř inbus civata
m8x90 half tooth imbus bolt

Product Code: **GYT-032**

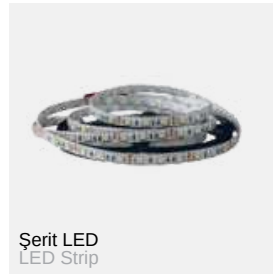

řerit LED
LED Strip

Product Code: **GYT-033**



řerit LED Kapađı
LED Strip Cover

Product Code: **GYT-034**



24 volt  zel Dimmerli Trafo
24 volt special Dimmer
Transformer

Product Code: **GYT-035**

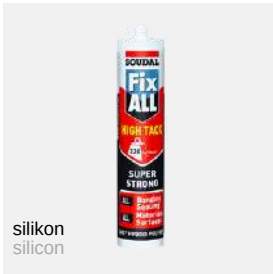

silikon
silicon

Product Code: **GYT-036**



Özellikler ve Kullanım Alanları

Features and Areas of Use

Giyotin silinebilir cam sistemleri, özellikle temizlik ve bakım kolaylığı sağlamak amacıyla tasarlanmış, dikey olarak hareket edebilen cam panellerden oluşan bir sistemdir. Bu sistemler, genellikle balkon, teras, kış bahçesi, restoran ve kafe gibi alanlarda kullanılır. Giyotin cam sistemlerinin silinebilir özellikte olması, camların hem iç hem de dış yüzeylerinin kolayca temizlenebilmesini sağlar.

Özellikleri:

1. Dikey Hareket: Cam paneller dikey olarak hareket eder ve üst üste kayarak açılıp kapanır. Bu, cam yüzeylere kolay erişim sağlar.
2. Silinebilirlik: Cam panellerin iç ve dış yüzeylerine kolay erişim sağlanarak temizlik kolaylaştırılır. Paneller tamamen açıldığında, her iki yüzey de rahatça silinebilir.
3. Malzeme: Temperli veya lamine camdan yapılır. Çerçeve ve ray sistemleri genellikle alüminyum veya paslanmaz çelikten üretilir.
4. Otomasyon: Elektrik motorları ile çalışabilir. Uzaktan kumanda veya akıllı ev sistemleri ile kontrol edilebilir. Manuel modeller de bulunabilir, ancak motorlu sistemler daha yaygındır.
5. Yalıtım: Isı, ses ve su yalıtımı sağlar. Cam panellerin arasındaki fitiller ve çerçeve sistemi bu yalıtımı destekler.
6. Güvenlik: Güvenlik kilitleri ve çocuk kilitleri gibi ek güvenlik önlemleri bulunabilir. Temperli cam kullanımı da güvenliği artırır.

Kullanım Alanları:

- Evlerde: Balkon, teras, veranda ve kış bahçelerinde kullanılır.
- Restoran ve Kafeler: Açık oturma alanlarını kapalı hale getirmek ve gerektiğinde açmak için kullanılır.
- Ofis ve Ticari Alanlar: İç mekanları dış ortamla entegre etmek ve doğal ışık almak amacıyla kullanılır.
- Oteller ve Tatil Köyleri: Konukların açık alanları kullanmasını sağlamak ve hava koşullarına göre bu alanları kapatmak için idealdir.

Giyotin silinebilir cam sistemleri, doğru malzeme ve tasarım kullanıldığında, hem fonksiyonel hem de estetik açıdan üstün çözümler sunar. Bu sistemler, çeşitli hava koşullarına dayanıklı olup, kullanıcıların açık alanları daha verimli ve konforlu bir şekilde kullanmalarını sağlar. Temizlik ve bakım kolaylığı sayesinde uzun ömürlü ve hijyenik bir kullanım sunar.

Guillotine wipeable glass systems are a system consisting of vertically movable glass panels, designed specifically for ease of cleaning and maintenance. These systems are generally used in areas such as balconies, terraces, winter gardens, restaurants and cafes. The fact that guillotine glass systems are wipeable allows both the interior and exterior surfaces of the glass to be easily cleaned.

Features:

1. Vertical Movement: Glass panels move vertically and slide open and closed on top of each other. This provides easy access to glass surfaces.
2. SWipeability: Easy access to the inner and outer surfaces of the glass panels facilitates cleaning. When the panels are fully opened, both surfaces can be easily wiped.
3. Material: Made of tempered or laminated glass. Frame and rail systems are usually made of aluminum or stainless steel.
4. Automation: Can be powered by electric motors. Can be controlled by remote control or smart home systems. Manual models can also be found, but motorized systems are more common.
5. Insulation: Provides heat, sound and water insulation. The wicks and frame system between the glass panels support this insulation.
6. Security: Additional security measures such as safety locks and child locks may be available. The use of tempered glass also increases security.

Areas of Use:

- In homes: Used in balconies, terraces, verandas and winter gardens.
- Restaurants and Cafes: Used to turn outdoor seating areas into closed areas and open them when necessary.
- Office and Commercial Areas: Used to integrate interior spaces with the exterior and to receive natural light.
- Hotels and Resorts: Ideal for allowing guests to use outdoor areas and closing these areas according to weather conditions.

Guillotine wipeable glass systems offer superior solutions in terms of both functionality and aesthetics when the right materials and designs are used. These systems are resistant to various weather conditions and allow users to use open spaces more efficiently and comfortably. They offer long-lasting and hygienic use thanks to their ease of cleaning and maintenance.



Silinebilir Otomatik Giyotin

Erasable Automatic Guillotine

Patentli tasarımıdır. Giyotinyum®, cam balkondan farklı olarak tam otomatik, uzaktan kumandalı %100 silinebilir cam sistemidir. Cam paneller, uzaktan kumanda ile açılır ya da kapanır. Sistem açıldığında balkonda yer kaplamaz. Aynı zamanda balkon korkuluğudur. Yerden yüksekte ve temizlenme ihtiyacı olan tüm mekanlar için yer kaplamadan ve diğer sistemlerine entegre olarak rahatlıkla kullanılabilir. Sistemde kullanılan paslanmaz zincir ile konforun tadını ömür boyu çıkarın.

It is a patented design. Unlike glass balcony, guillotine® is a fully automatic, remote controlled 100% wipeable glass system. Glass panels are opened or closed with a remote control. When the system is opened, it does not take up space on the balcony. It is also a balcony railing. It can be easily used for all spaces that are above the ground and need cleaning, without taking up space and integrated with other systems. Enjoy the comfort for a lifetime with the stainless chain used in the system.



Patentli, Güvenli Temizlik Sistemi, Parkmak Sıkışmasına Engel Trabzan!

Giyotinyum®, emniyetli kullanım ve temizlik için özel olarak tasarlandı. Temizlik için dışarı sarmaya, merdivene çıkmaya, camın arasına girmeye gerek yok. Panelleri temizlik moduna getirin. Rahat, kolay ve güvenli şekilde temizleyin. Sistem, parmak sıkışmasına engel özel hareketli trabzan profili ile daha da güvenli!

Guillotinyum® is specially designed for safe use and cleaning. There is no need to lean out, climb a ladder or get between the glass for cleaning. Put the panels in cleaning mode. Clean comfortably, easily and safely. The system is even safer with a special moving handrail profile that prevents finger pinching!



Sistem Genişliği	Maks. 4000mm
Sistem Yüksekliği	Maks. 3500mm
Panel Konfigürasyonu	2 Panel 3 Panel
Cam Tipi	Temperli Isıcam veya Temperli 8 mm
Cam Kalınlığı	Temperli
Kilit Seçenekleri	4+12+4mm - 5+10+5mm Comfort Lock
Hareket Mekanizması	Inox (Paslanmaz Çelik) Zincir
Motor Seçenekleri	Somfy Mosel Cuppon

*Maksimum sistem boyutları için, rüzgar yükü bilgisi ile firmamızdan onay alınız

Demonte Üretim
Kapasitemiz
Our Disassembled Production Capacity

Boyama
Kapasitemiz
Our Painting Capacity

1 milyon

m2 Yıllık
m2 per year

2.000

ton yıllık
tons per year

m

Production facility

24.000

45'den fazla Ülkeye ihracat
Export to more than 45 Countries

100 Çalışan
100 Employees

TKN GROUP **ALL OVER THE WORLD**



TKN[®]
GROUP Hareketli Yapı Sistemleri

Yüksek Kalite **Gölgelendirme** **Sistemleri Üretiyoruz**

We Produce High Quality Shading Systems

Firma Tanıtım
Videosunu izleyin

Watch the Company
Introduction Video







TKN[®]
GROUP

Hareketli Yapı Sistemleri

TKN GROUP ALÜMİNYUM SANAYİ VE TİCARET LİMİTED ŞİRKETİ

Akkapı Mah.12254 Sok.No: 139/A Seyhan / ADANA



detaylı bilgi ve iletişim

+90 546 121 01 73

+90 546 120 01 73

+90 506 101 05 73

www.tkngroup.com.tr

Yüksek Kaliteli ürünler

High Quality products

Hızlı termin

Fast delivery

Uygun fiyat

Affordable price

